

**Key Parameters**

$V_{RRM}$	= 2800V
$I_{F(AV)}$	= 318A
$I_{FSM}$	= 8500A
$V_{F(TO)}$	= 0.80V
$r_F$	= 0.67m $\Omega$

**Features**

- Full blocking capability over wide temperature range
- Pressure contacts technology for high reliability

**Applications**

- Power Supplies
- Uncontrolled Rectifiers
- Welding
- Induction Heating / Melting
- Battery Chargers

**Ordering Information**

MS D	318	N	XX	F	K
Rectifier Diode	Current code	Polarity R= Base Anode N= Base Cathode	Voltage Code Code X 100 = $V_{RRM}$	F = Flat Base	Technology K = Pressure Contact Technology
Order Code MS D318N28FK : 2800V $V_{RRM}$ , Flat base, Diode with base Cathode					

Prepared by : ABA	Date of Publication : 25.03.2015
Approved by : RBS	Revision : 0

Symbol	Characteristic	Conditions	T <sub>j</sub> [°C]	Value	Unit
<b>BLOCKING</b>					
V <sub>RRM</sub>	Repetitive peak reverse voltage		160	200 - 2800	V
V <sub>RSM</sub>	Non-repetitive peak reverse voltage		160	300 - 2900	V
I <sub>RRM</sub>	Repetitive peak reverse current	V = V <sub>RRM</sub>	160	50	mA
<b>CONDUCTING</b>					
I <sub>F(AV)</sub>	Mean forward current	180° sin ,50 Hz, T <sub>c</sub> =120°C 180° sin ,50 Hz, T <sub>c</sub> =105°C		318 400	A
I <sub>FRMS</sub>	RMS current	T <sub>c</sub> =105°C		628	A
I <sub>FSM</sub>	Surge forward current	Sine wave, 10 ms Without reverse voltage	25	8500	A
			160	7500	A
I <sup>2</sup> t	I <sup>2</sup> t	Sine wave, 10 ms Without reverse voltage	25	361 x 10 <sup>3</sup>	A <sup>2</sup> s
			160	281 x 10 <sup>3</sup>	A <sup>2</sup> s
V <sub>F</sub>	Forward voltage	On-state current = 1260A	160	1.75	V
V <sub>F(TO)</sub>	Threshold voltage		160	0.80	V
r <sub>F</sub>	Forward slope resistance		160	0.67	mΩ
<b>MOUNTING</b>					
R <sub>th(j-c)</sub>	Thermal impedance, sin 180°	Junction to case		0.094	°C/W
R <sub>th(c-h)</sub>	Thermal impedance	Case to heatsink		0.02	°C/W
T <sub>j</sub>	Max. junction temperature			160	°C
T <sub>stg</sub>	Storage temperature			-40 .... 160	°C
M	Mounting torque			1.66 - 2.07	KgM
W	Weight (Approx.)			530	gm
			Prepared by : ABA	Date of Publication : 25.03.2015	
			Approved by : RBS	Revision : 0	

DISSIPATION CHARACTERISTICS

SINE WAVE

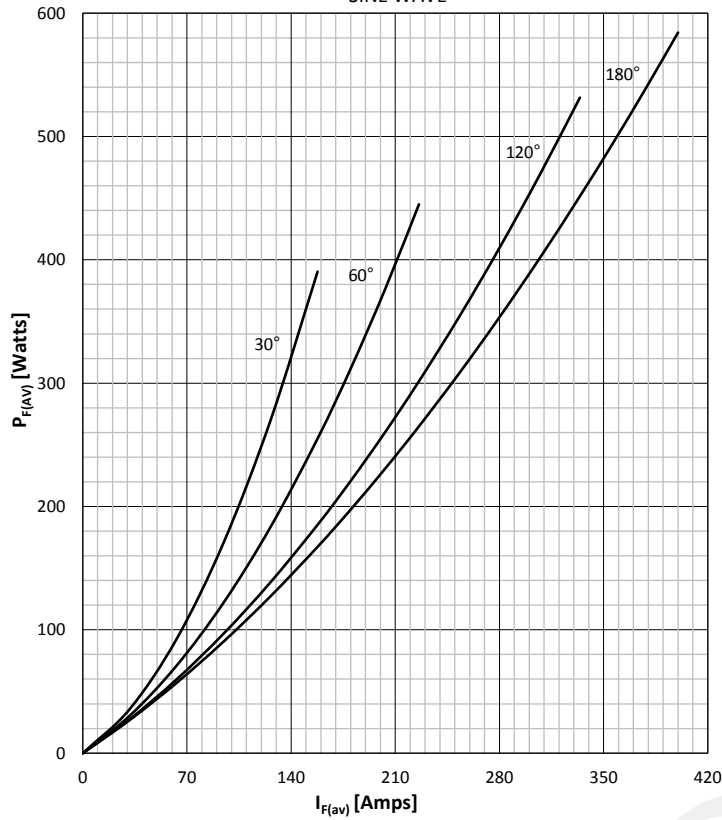

FORWARD CURRENT DERATING CURVE

SINE WAVE

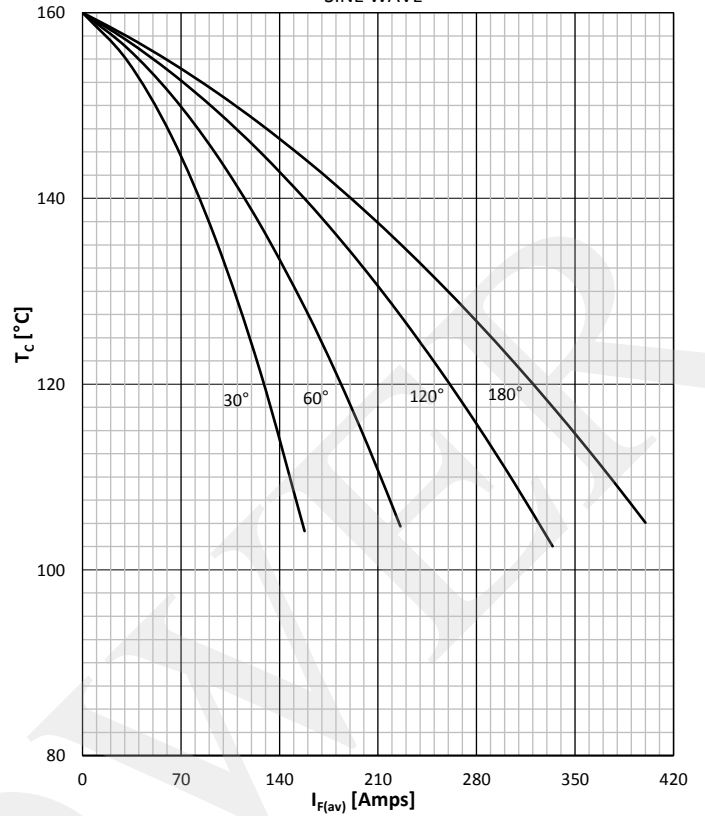

DISSIPATION CHARACTERISTICS

SQUARE WAVE

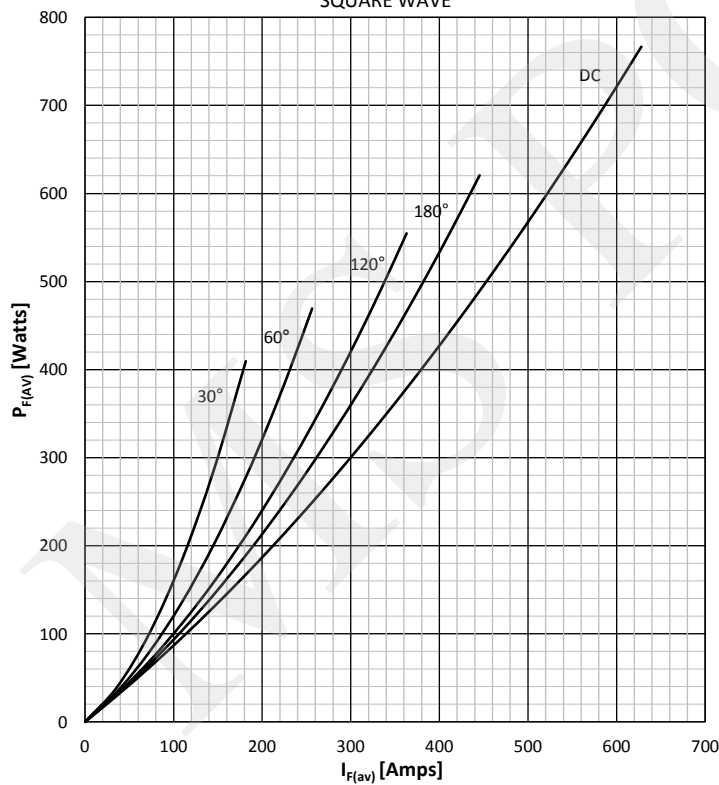

FORWARD CURRENT DERATING CURVE

SQUARE WAVE

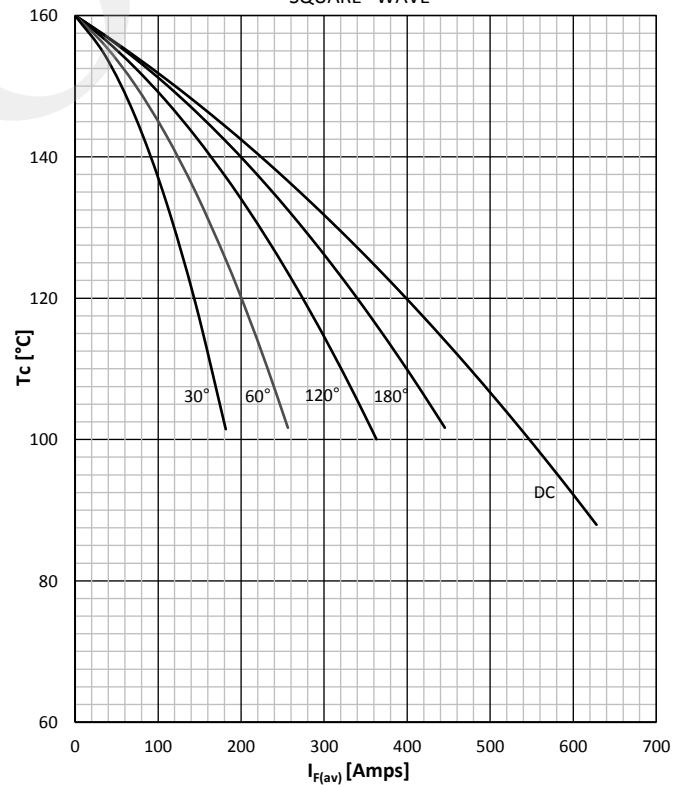

Prepared by : ABA

Date of Publication : 25.03.2015

Approved by : RBS

Revision : 0

FORWARD CHARACTERISTIC

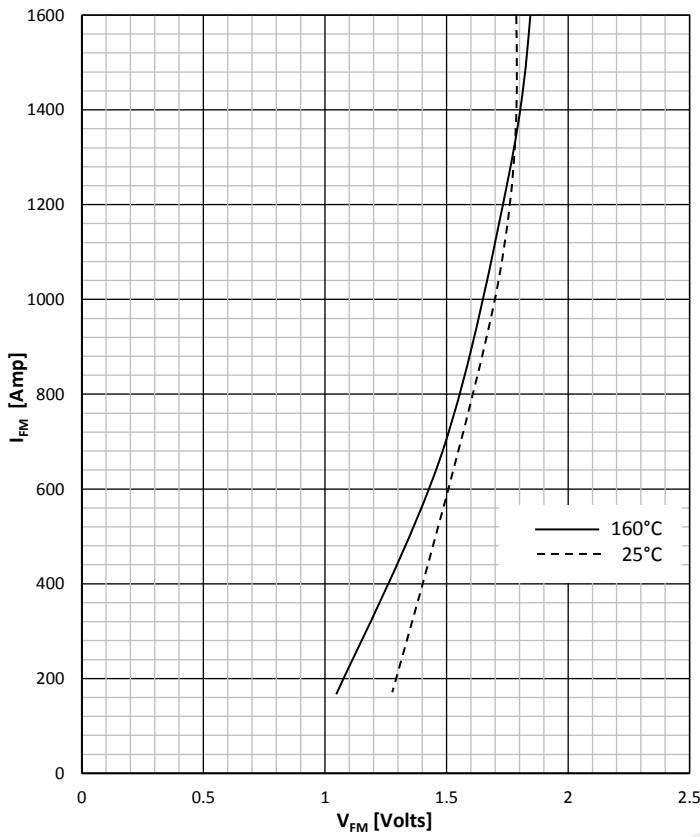

SURGE CHARACTERISTICS

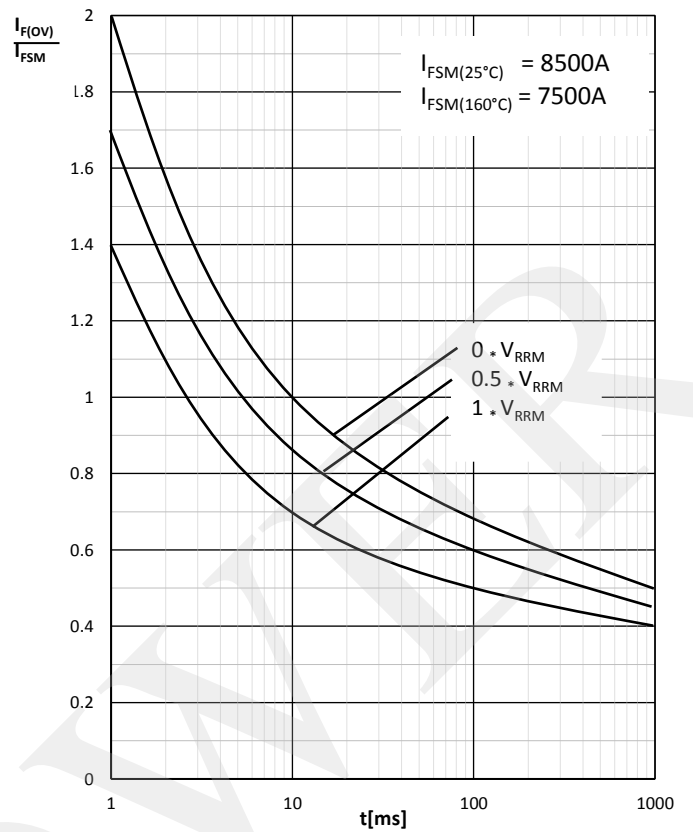

TRANSIENT THERMAL IMPEDANCE

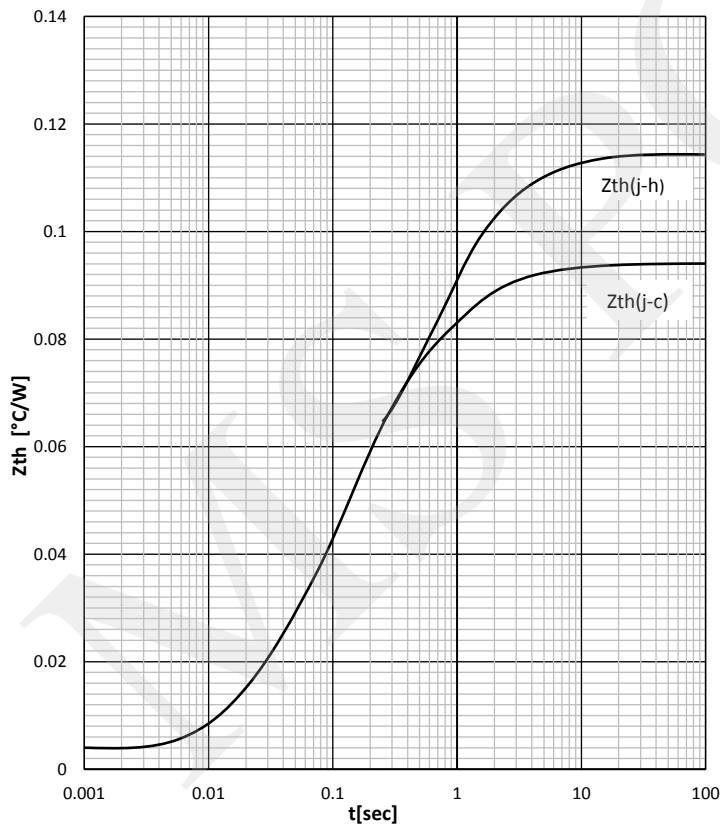

Prepared by : ABA	Date of Publication : 25.03.2015
Approved by : RBS	Revision : 0

## Outline

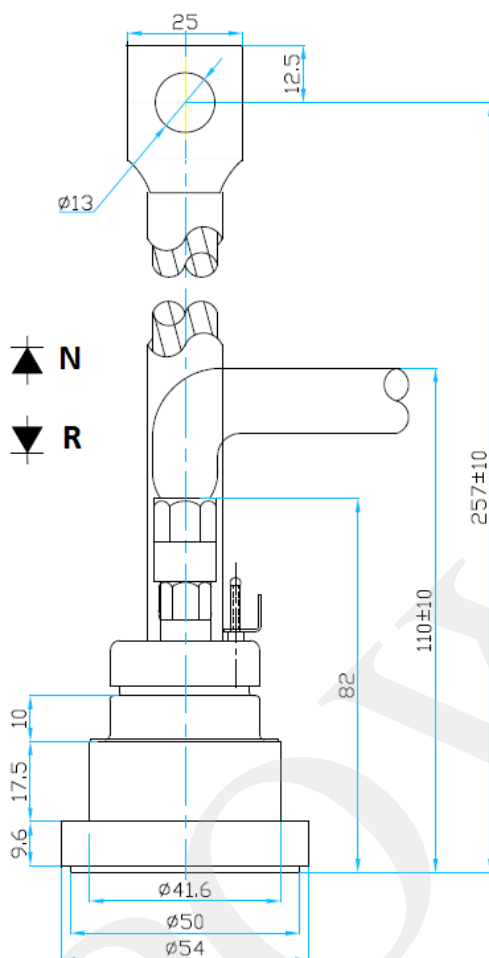

### MS Power GmbH

Mergenthalerallee 79-81  
65760 Eschborn, Germany  
Web: [www.mspowergroup.com](http://www.mspowergroup.com)  
Mail: [info@mspowergroup.de](mailto:info@mspowergroup.de)

#### Sales & Enquiry:

[sales@mspowergroup.de](mailto:sales@mspowergroup.de)

#### Technical Support:

[solution@mspowergroup.de](mailto:solution@mspowergroup.de)

#### After sales Service:

[service@mspowergroup.de](mailto:service@mspowergroup.de)

Phone: +49 (0) 6196/7768 666

Fax: +49 (0) 6196/7757 888



Prepared by : ABA

Date of Publication : 25.03.2015

Approved by : RBS

Revision : 0

**Terms & Conditions of usage :**

The data contained in this product datasheet is exclusively Intended for technically trained staff. You and your technical departments will have to evaluate the suitability of the product for the intended application and the completeness of the product data with respect to such application. This product datasheet is describing the characteristics of this product for which a warranty is granted. Any such warranty is granted exclusively pursuant the terms and conditions of the supply agreement. There will be no guarantee of any kind for the product and its characteristics. The information in the valid application-and assembly notes of the device must be considered.

Should you require product information in excess of the data given in this product datasheet or which concerns the specific application of our product, please contact the sales office, which is responsible for you (see [www.mspowergroup.com](http://www.mspowergroup.com)). For those that are specifically interested we may provide application notes.

Due to technical requirements our product may contain dangerous substances. For information on the types in question please contact the sales office, which is responsible for you.

Should you intend to use the Product in aviation applications, in health or live endangering or life support applications, please notify. Please note, that for any such applications we urgently recommend

- to perform joint Risk and Quality Assessments;
- the conclusion of Quality Agreements;
- to establish joint measures of an ongoing product survey, and that we may make delivery depended on the realization of any such measures.

If and to the extent necessary, please forward equivalent notices to your customers.

Changes of this product datasheet are reserved.

Prepared by : ABA	Date of Publication : 25.03.2015
Approved by : RBS	Revision : 0