



Key Parameters

V_{RRM}	= 3400V
$I_{F(AV)}$	= 3360A
I_{FSM}	= 38000A
$V_{F(TO)}$	= 0.82V
r_F	= 0.128mΩ

Features

- Full blocking capability over wide temperature range
- Hermetically sealed ceramic package
- High case non-rupture current

Applications

- Traction Rectifiers
- Uncontrolled Rectifiers
- Welding
- Induction Heating / Melting

Ordering Information

MS D	3360	C	XX
Rectifier Diode	Current code	C - Capsule package with Alloyed silicon technology	Voltage Code Code X 100 = V_{RRM}
Order Code MS D3360C34 : 3400V V_{RRM} , Capsule Diode			

Prepared by : ABA	Date of Publication : 25.03.2015
Approved by : RBS	Revision : 0

Symbol	Characteristic	Conditions	T _j [°C]	Value	Unit
BLOCKING					
V _{RRM}	Repetitive peak reverse voltage		175	2400 - 3400	V
V _{RSM}	Non-repetitive peak reverse voltage		175	2500 - 3500	V
I _{RRM}	Repetitive peak reverse current	V = V _{RRM}	175	250	mA
CONDUCTING					
I _{F(AV)}	Mean forward current	180° sin, 50 Hz, T _c =85°C, double side cooled 180° sin, 50 Hz, T _c =75°C, double side cooled		3360 3590	A
I _{FRMS}	RMS current	T _c =75°C, double side cooled		5636	A
I _{FSM}	Surge forward current	Sine wave, 10 ms Without reverse voltage	25	38000	A
			175	36500	A
I ² t	I ² t	Sine wave, 10 ms Without reverse voltage	25	7220 x 10 ³	A ² s
			175	6661 x 10 ³	A ² s
V _F	Forward voltage	On-state current = 3000A	25	1.35	V
V _{F(TO)}	Threshold voltage		175	0.82	V
r _F	Forward slope resistance		175	0.128	mΩ
MOUNTING					
R _{th(j-c)}	Thermal impedance, sin 180°	Junction to case, double side cooled		0.0143	°C/W
R _{th(c-h)}	Thermal impedance	Case to heatsink, double side cooled		0.004	°C/W
T _j	Max. junction temperature			175	°C
T _{stg}	Storage temperature			-40 175	°C
M	Clamping force			40 - 50	KN
W	Weight (Approx.)			820	gm
			Prepared by : ABA	Date of Publication : 25.03.2015	
			Approved by : RBS	Revision : 0	

DISSIPATION CHARACTERISTICS

SINE WAVE

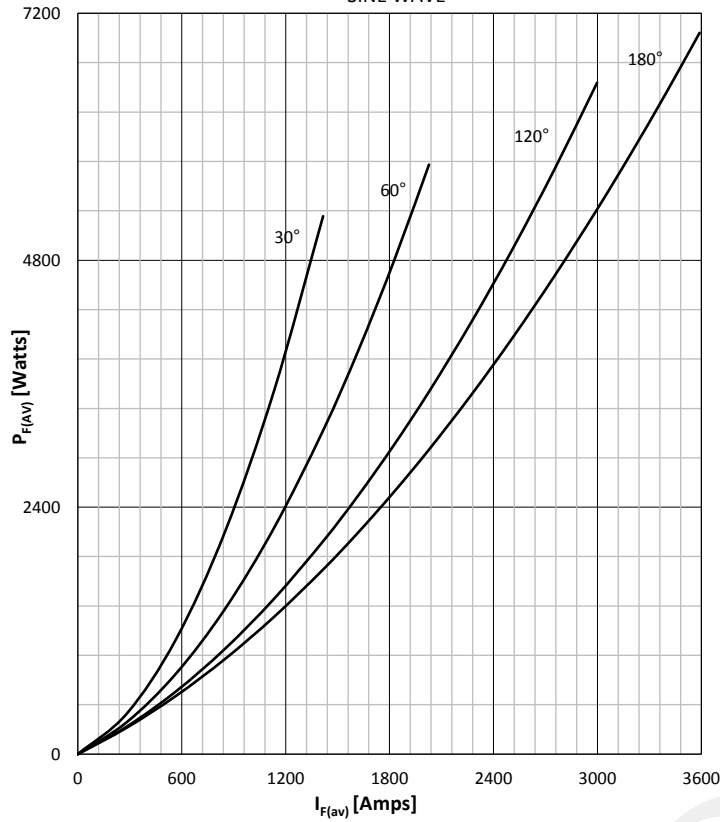

FORWARD CURRENT DERATING CURVE

SINE WAVE

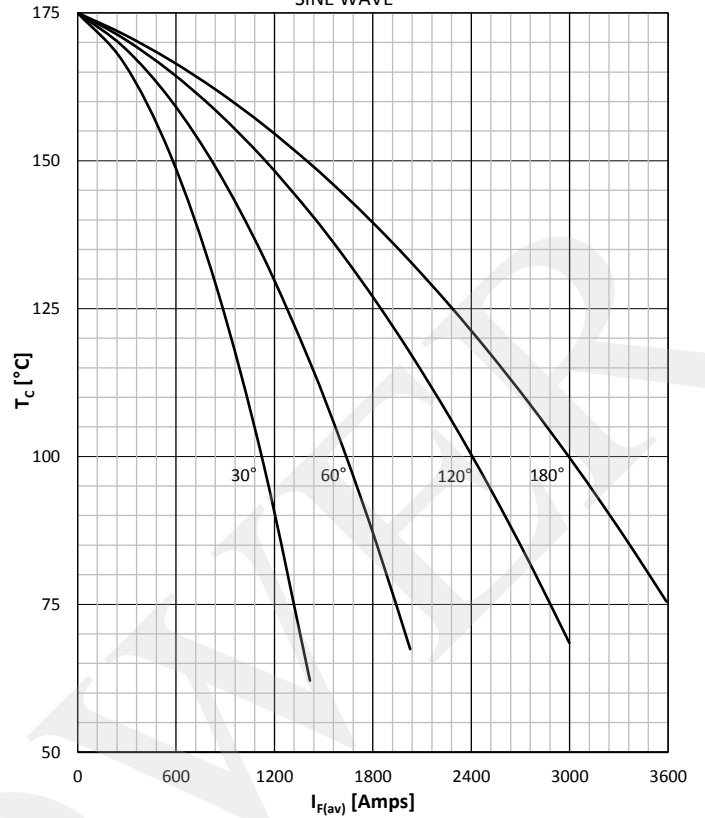

DISSIPATION CHARACTERISTICS

SQUARE WAVE

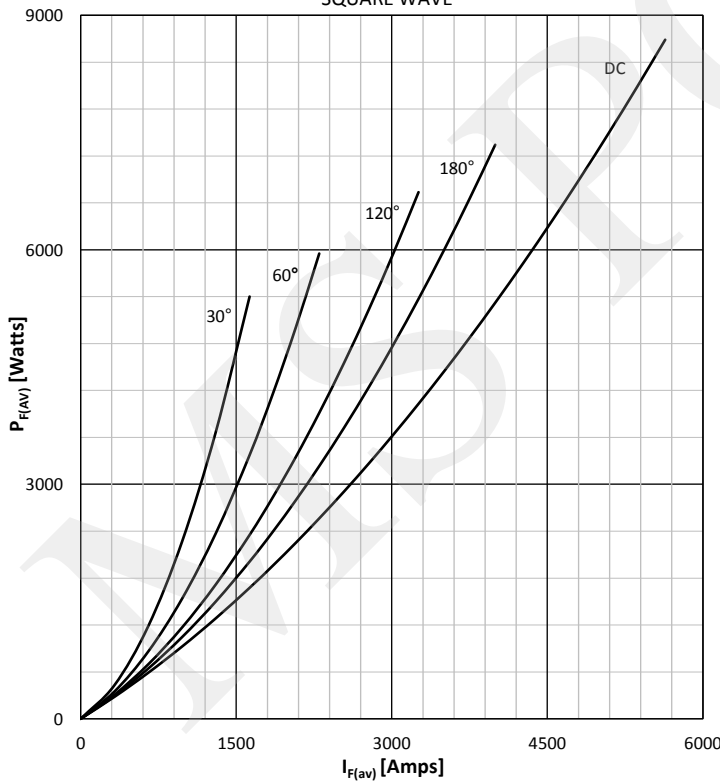

FORWARD CURRENT DERATING CURVE

SQUARE WAVE

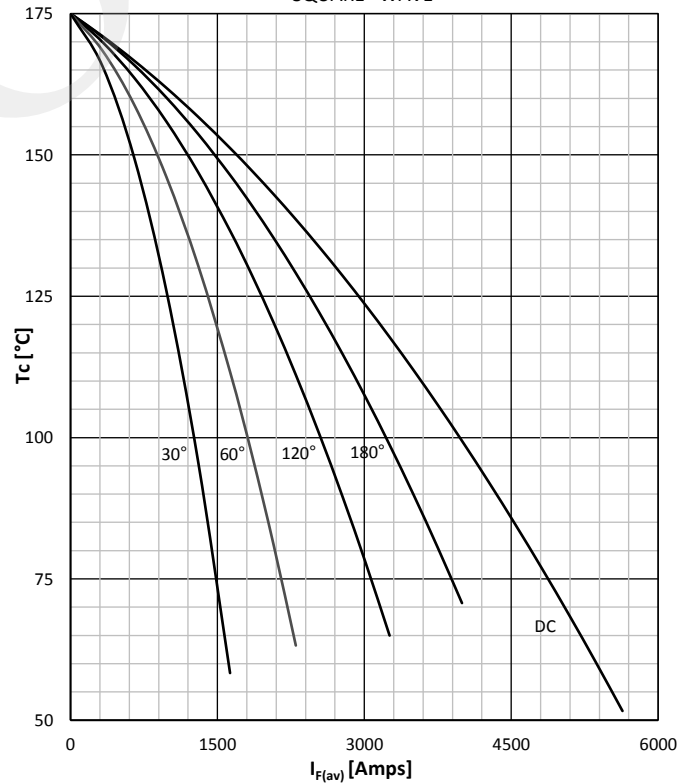

Prepared by : ABA

Date of Publication : 25.03.2015

Approved by : RBS

Revision : 0

FORWARD CHARACTERISTIC

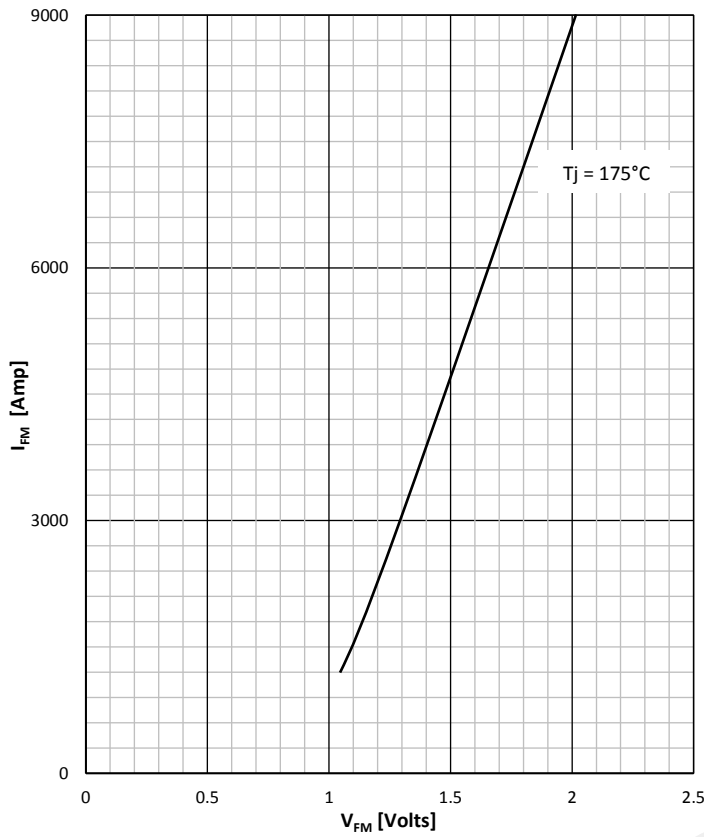

SURGE CHARACTERISTICS

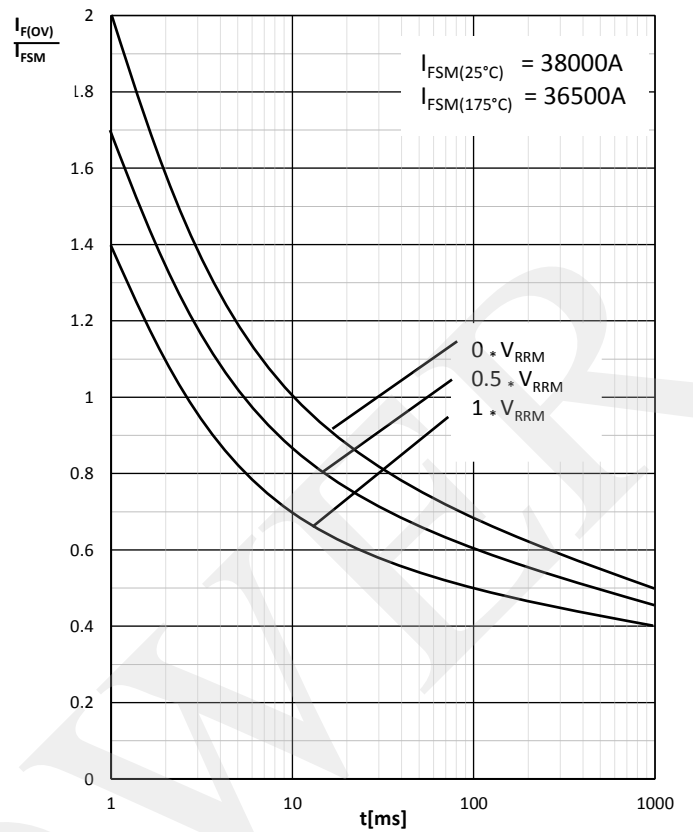

TRANSIENT THERMAL IMPEDANCE

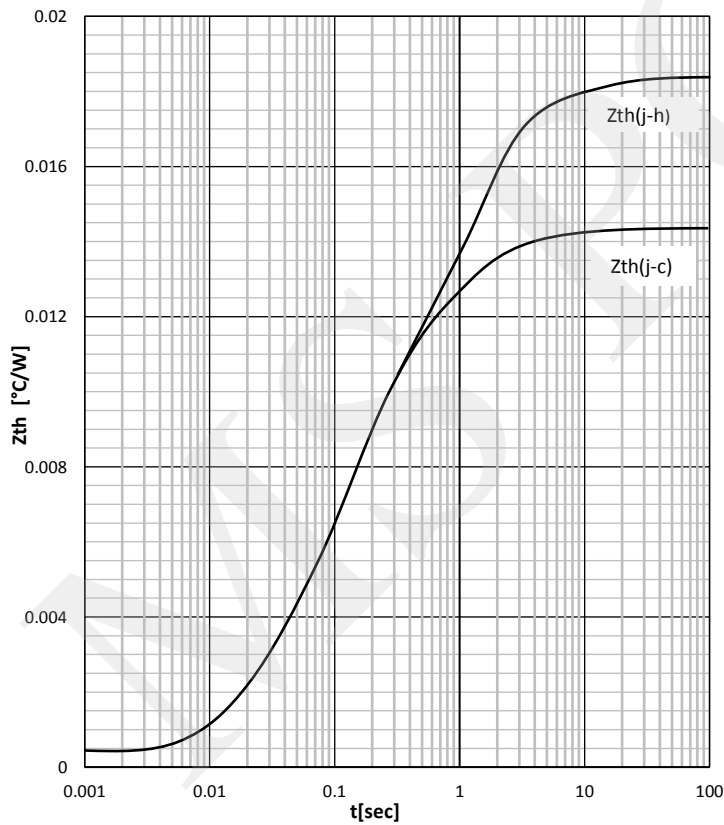

Prepared by : ABA	Date of Publication : 25.03.2015
Approved by : RBS	Revision : 0

Outline

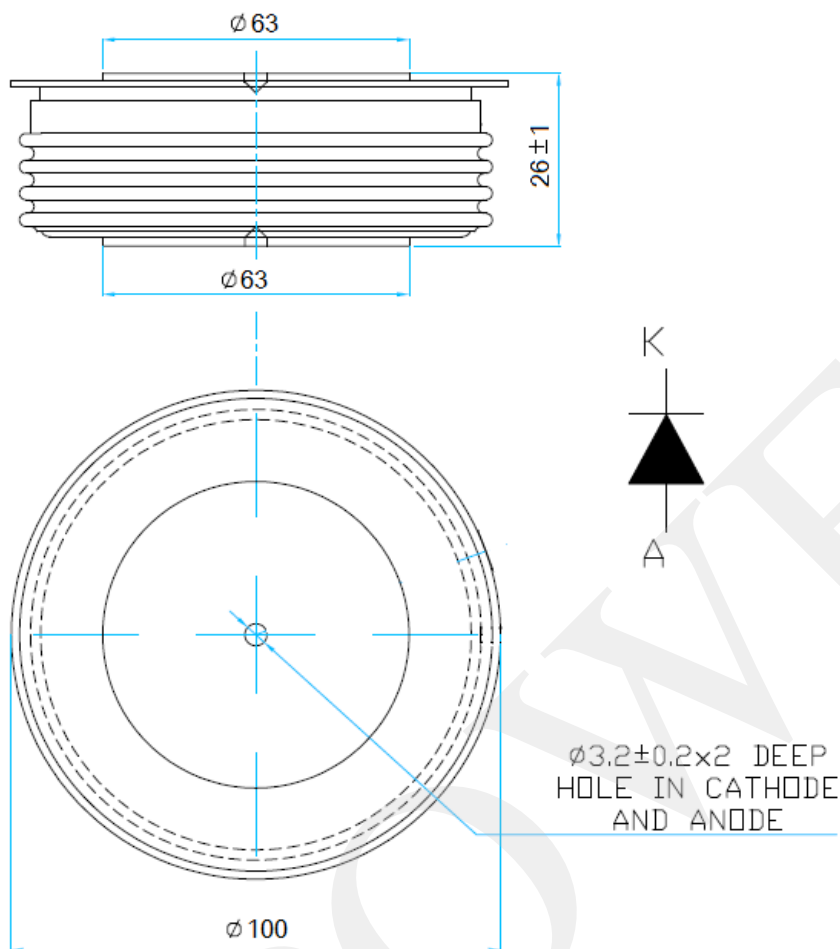

MS Power GmbH

Mergenthalerallee 79-81
65760 Eschborn, Germany
Web: www.mspowergroup.com
Mail: info@mspowergroup.de

Sales & Enquiry:

sales@mspowergroup.de

Technical Support:

solution@mspowergroup.de

After sales Service:

service@mspowergroup.de

Phone: +49 (0) 6196/7768 666

Fax: +49 (0) 6196/7757 888



Prepared by : ABA

Date of Publication : 25.03.2015

Approved by : RBS

Revision : 0

Terms & Conditions of usage :

The data contained in this product datasheet is exclusively Intended for technically trained staff. You and your technical departments will have to evaluate the suitability of the product for the intended application and the completeness of the product data with respect to such application. This product datasheet is describing the characteristics of this product for which a warranty is granted. Any such warranty is granted exclusively pursuant the terms and conditions of the supply agreement. There will be no guarantee of any kind for the product and its characteristics. The information in the valid application-and assembly notes of the device must be considered.

Should you require product information in excess of the data given in this product datasheet or which concerns the specific application of our product, please contact the sales office, which is responsible for you (see www.mspowergroup.com). For those that are specifically interested we may provide application notes.

Due to technical requirements our product may contain dangerous substances. For information on the types in question please contact the sales office, which is responsible for you.

Should you intend to use the Product in aviation applications, in health or live endangering or life support applications, please notify. Please note, that for any such applications we urgently recommend

- to perform joint Risk and Quality Assessments;
- the conclusion of Quality Agreements;
- to establish joint measures of an ongoing product survey, and that we may make delivery depended on the realization of any such measures.

If and to the extent necessary, please forward equivalent notices to your customers.

Changes of this product datasheet are reserved.

Prepared by : ABA	Date of Publication : 25.03.2015
Approved by : RBS	Revision : 0