



Key Parameters

V_{RRM}	= 1800V
$I_{F(AV)}$	= 25A
I_{FSM}	= 600A
$V_{F(TO)}$	= 0.85V
r_F	= 6.0mΩ

Features

- Full blocking capability over wide temperature range
- Heat transfer through aluminium oxide ceramic isolated metal baseplate
- Hard soldered joints for high reliability

Applications

- Power Supplies
- Uncontrolled Rectifiers
- Field supply for DC motors
- Battery Chargers
- UPS

Ordering Information

MS	DD	25	XX	S	XX
Fixed code	DD- Diode- Diode Module	Current Code	Voltage Code Code X 100 = V_{RRM}	Technology S = Solder Bond Technology	None - Standard connection AA - Common Anode KK - Common Cathode
Order Code MS DD25S18KK : 1800V V_{RRM} , Common Cathode , Diode-Diode Module					

Prepared by : ABA	Date of Publication : 25.03.2015
Approved by : RBS	Revision : 0

Symbol	Characteristic	Conditions	T _j [°C]	Value	Unit
BLOCKING					
V _{RRM}	Repetitive peak reverse voltage		150	200 - 1800	V
V _{RSM}	Non-repetitive peak reverse voltage		150	300 - 1900	V
I _{RRM}	Repetitive peak reverse current	V = V _{RRM}	150	3	mA
CONDUCTING					
I _{F(AV)}	Mean forward current	180° sin ,50 Hz, T _c =100°C		25	A
I _{FRMS}	RMS current	T _c =100°C		40	A
I _{FSM}	Surge forward current	Sine wave, 10 ms Without reverse voltage	25	600	A
			150	500	A
I ² t	I ² t	Sine wave, 10 ms Without reverse voltage	25	1800	A ² s
			150	1250	A ² s
V _F	Forward voltage	On-state current = 80A	25	1.40	V
V _{F(TO)}	Threshold voltage		150	0.85	V
r _F	Forward slope resistance		150	6.0	mΩ
MOUNTING					
R _{th(j-c)}	Thermal impedance, sin 180°	Junction to case, per arm per module		1.6 0.8	°C/W
R _{th(c-h)}	Thermal impedance	Case to heatsink, per arm per module		0.2 0.1	°C/W
T _j	Max. junction temperature			150	°C
T _{stg}	Storage temperature			-40 ... 125	°C
V _{ISOL}	Insulation test voltage,RMS	F=50Hz, 1min		2.5	KV
M1	Mounting torque			5 ± 15%	Nm
M2	Terminal connection torque			3 ± 15%	Nm
W	Weight (Approx.)			105	gm
			Prepared by : ABA	Date of Publication : 25.03.2015	
			Approved by : RBS	Revision : 0	

DISSIPATION CHARACTERISTICS

SINE WAVE

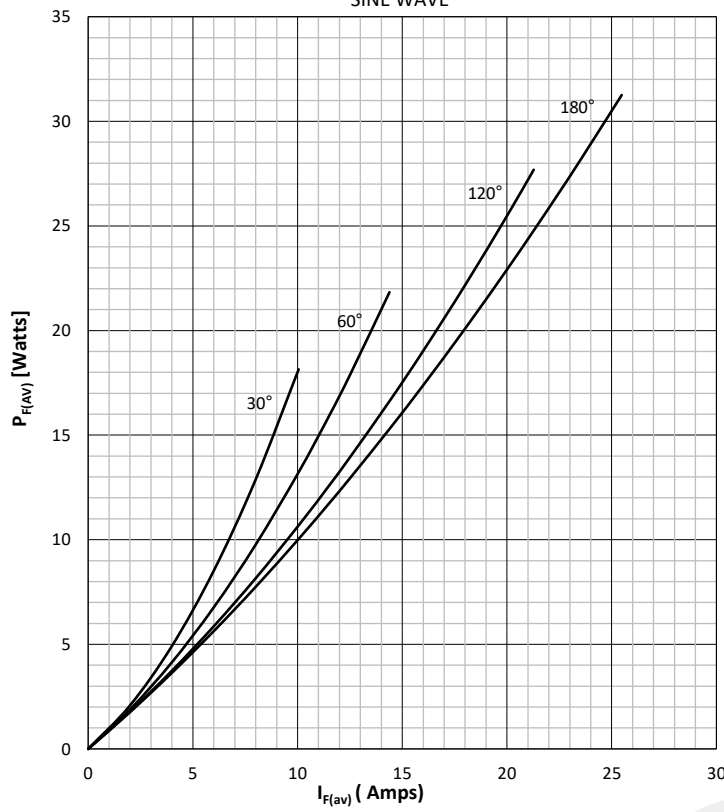

FORWARD CURRENT DERATING CURVE

SINE WAVE

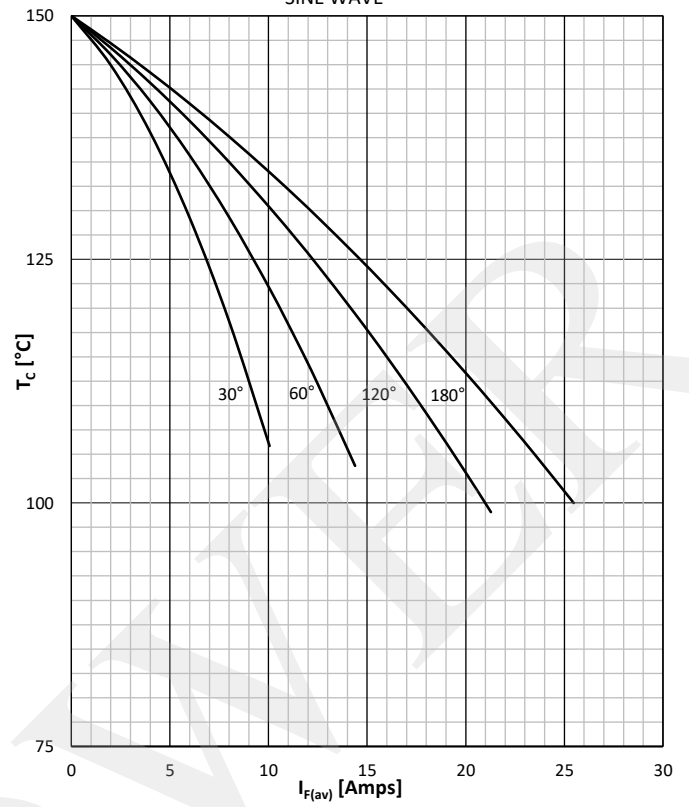

DISSIPATION CHARACTERISTICS

SQUARE WAVE

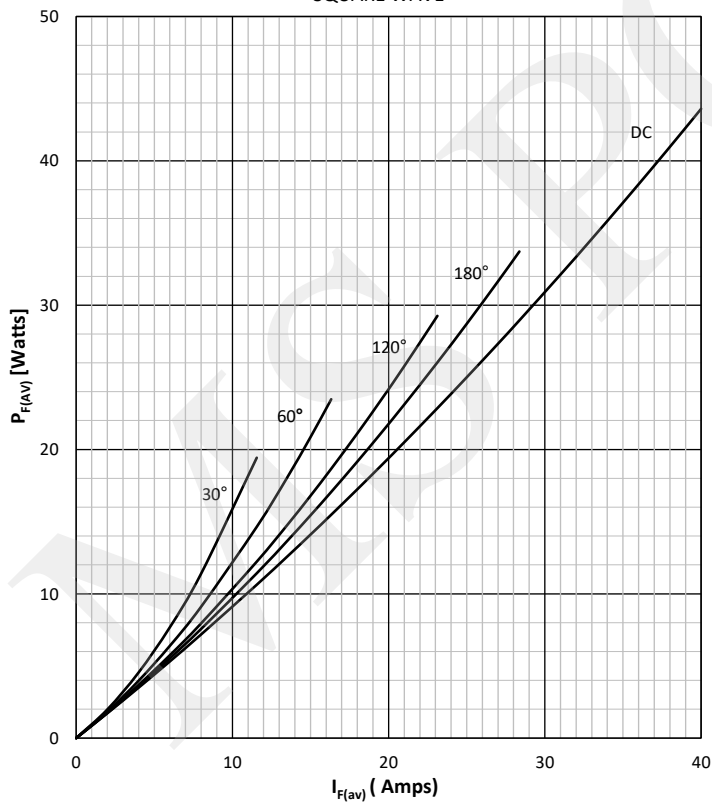

FORWARD CURRENT DERATING CURVE

SQUARE WAVE

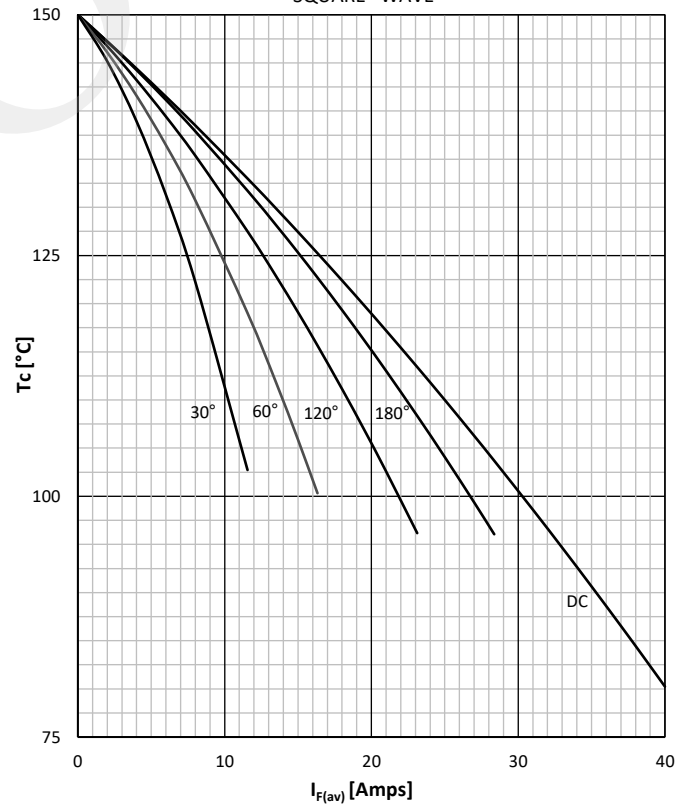

Prepared by : ABA	Date of Publication : 25.03.2015
Approved by : RBS	Revision : 0

FORWARD CHARACTERISTIC

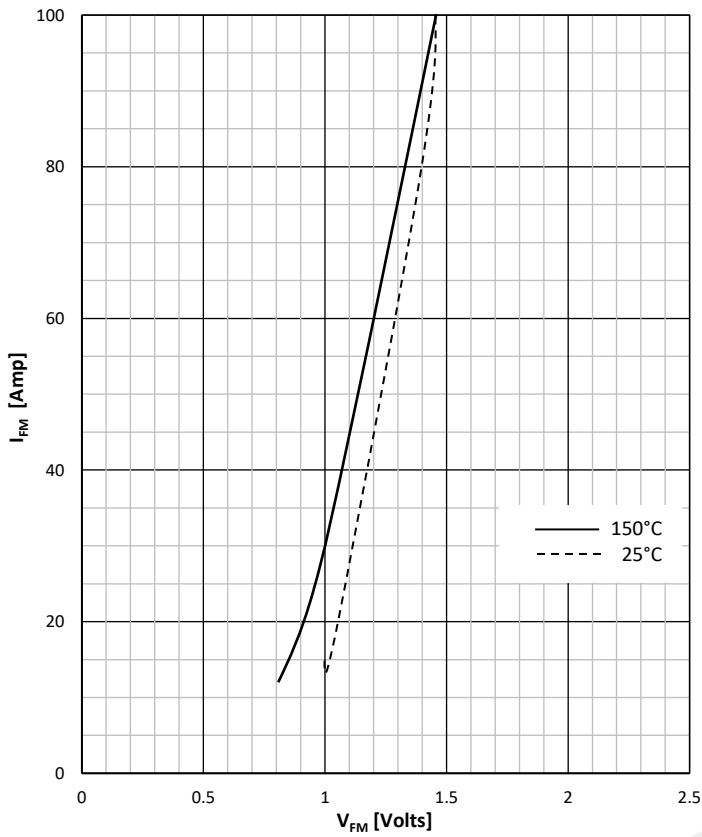

SURGE CHARACTERISTICS

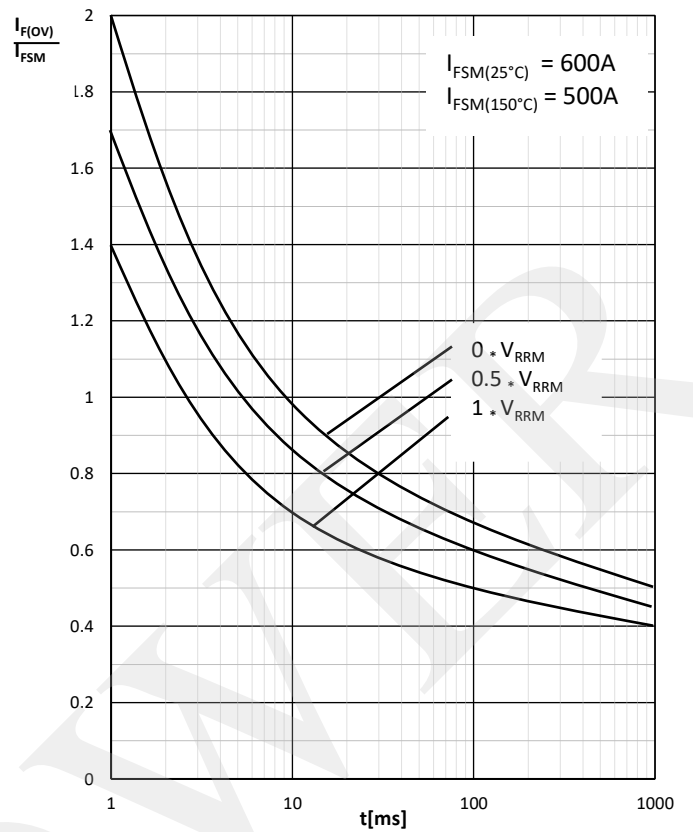

TRANSIENT THERMAL IMPEDANCE

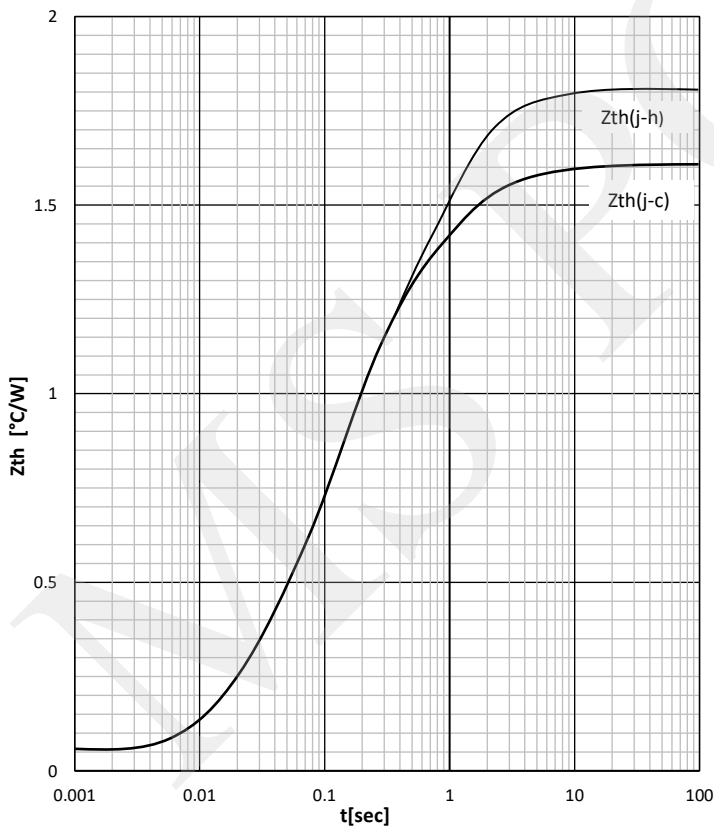

Prepared by : ABA	Date of Publication : 25.03.2015
Approved by : RBS	Revision : 0

Outline

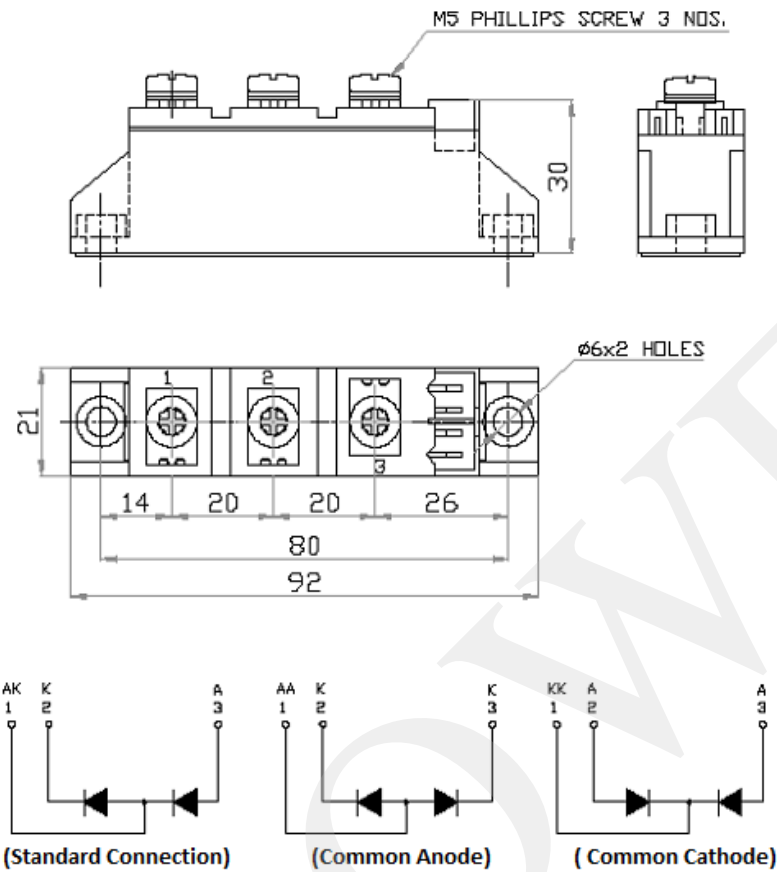

MS Power GmbH

Mergenthalerallee 79-81
65760 Eschborn, Germany
Web: www.mspowergroup.com
Mail: info@mspowergroup.de

Sales & Enquiry:
sales@mspowergroup.de

Technical Support:
solution@mspowergroup.de

After sales Service:
service@mspowergroup.de

Phone: +49 (0) 6196/7768 666
Fax: +49 (0) 6196/7757 888



Prepared by : ABA	Date of Publication : 25.03.2015
Approved by : RBS	Revision : 0

Terms & Conditions of usage :

The data contained in this product datasheet is exclusively Intended for technically trained staff. You and your technical departments will have to evaluate the suitability of the product for the intended application and the completeness of the product data with respect to such application. This product datasheet is describing the characteristics of this product for which a warranty is granted. Any such warranty is granted exclusively pursuant the terms and conditions of the supply agreement. There will be no guarantee of any kind for the product and its characteristics. The information in the valid application-and assembly notes of the device must be considered.

Should you require product information in excess of the data given in this product datasheet or which concerns the specific application of our product, please contact the sales office, which is responsible for you (see www.mspowergroup.com). For those that are specifically interested we may provide application notes.

Due to technical requirements our product may contain dangerous substances. For information on the types in question please contact the sales office, which is responsible for you.

Should you intend to use the Product in aviation applications, in health or live endangering or life support applications, please notify. Please note, that for any such applications we urgently recommend

- to perform joint Risk and Quality Assessments;
- the conclusion of Quality Agreements;
- to establish joint measures of an ongoing product survey, and that we may make delivery depended on the realization of any such measures.

If and to the extent necessary, please forward equivalent notices to your customers.

Changes of this product datasheet are reserved.

Prepared by : ABA	Date of Publication : 25.03.2015
Approved by : RBS	Revision : 0