



Key Parameters

V_{RRM}	= 3400V
$I_{F(AV)}$	= 960A
I_{FSM}	= 14000A
$V_{F(TO)}$	= 0.75V
r_F	= 0.52mΩ

Features

- Full blocking capability over wide temperature range
- Hermetically sealed ceramic package
- High case non-rupture current

Applications

- Traction Rectifiers
- Uncontrolled Rectifiers
- Induction Heating / Melting

Ordering Information

MS PERI	D	960	CZ	X X
Fixed Code	Rectifier Diode	Current code	CZ - Capsule package with Free floating silicon Technology	Voltage Code Code X 100 = V_{RRM}
Order Code MS PERI D960CZ34 : 3400V V_{RRM} , Capsule Diode				

Prepared by : ABA	Date of Publication : 31.08.2018
Approved by :	Revision : 0

Symbol	Characteristic	Conditions	T _j [°C]	Value	Unit
BLOCKING					
V _{RRM}	Repetitive peak reverse voltage		175	3400	V
V _{RSM}	Non-repetitive peak reverse voltage		175	3500	V
I _{RRM}	Repetitive peak reverse current	V = V _{RRM}	175	60	mA
CONDUCTING					
I _{F(AV)}	Mean forward current	180° sin, 50 Hz, T _c =100°C, double side cooled		960	A
I _{FRMS}	RMS current			1510	A
I _{FSM1}	Surge forward current	Sine wave, 10 ms Without reverse voltage	175	14000	A
I ² t	I ² t		175	980 x 10 ³	A ² s
V _F	Forward voltage	On-state current = 1500A	175	1.53	V
V _{F(TO)}	Threshold voltage		175	0.75	V
r _F	Forward slope resistance		175	0.52	mΩ
SWITCHING					
Q _{rr}	Reverse recovery charge	I _{FM} =1000A, -di _F /dt = 10A/μs, V _R = 100V, t _p =2000μs	175	4200	μC
THERMAL					
R _{th(j-c)}	Thermal impedance, sin 180°	Junction to case, double side cooled		0.036	°C/W
R _{th(c-h)}	Thermal impedance	Case to heatsink, double side cooled		0.0075	°C/W
T _j	Max. junction temperature			175	°C
T _{stg}	Storage temperature			-40 175	°C
MECHANICAL					
M	Clamping force			8 - 12	KN
W	Weight (Approx.)			260	gm
D _s	Surface creepage distance			25	mm
D _a	Air strike distance			14	mm
			Prepared by : ABA	Date of Publication : 31.08.2018	
			Approved by :	Revision : 0	

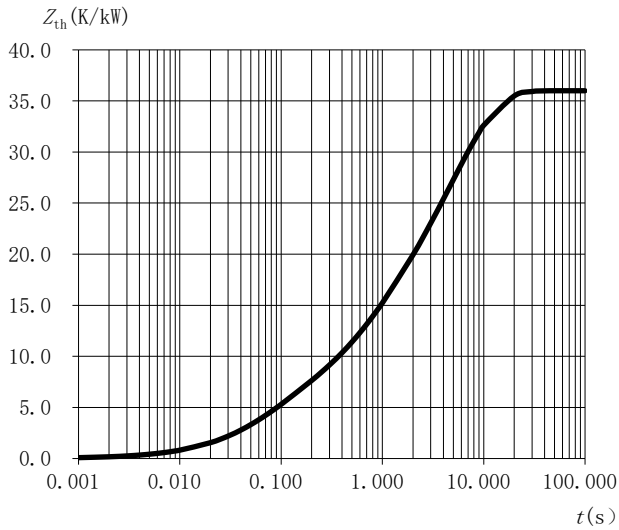

Fig.1 : Transient thermal impedance (junction-to-case) vs. time

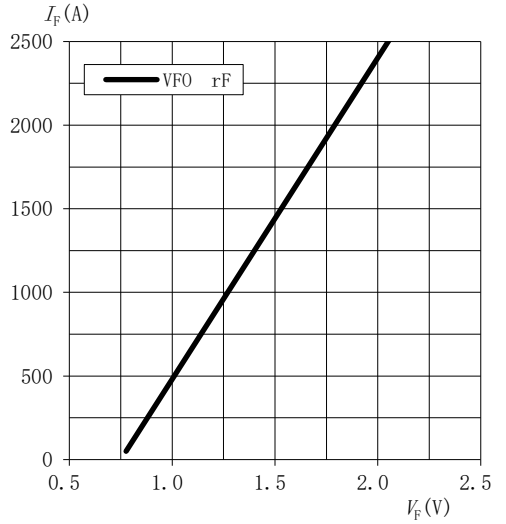

Fig.2 : On-state V-I characteristics

$$Z_{th(j-c)}(t) = \sum_{i=1}^n R_i(1 - e^{-t/\tau_i})$$

<i>i</i>	1	2	3	4
$R_i(K/kW)$	22.3579	5.8105	4.4211	3.4105
$\tau_i(s)$	5.2926	0.9707	0.0663	0.3385

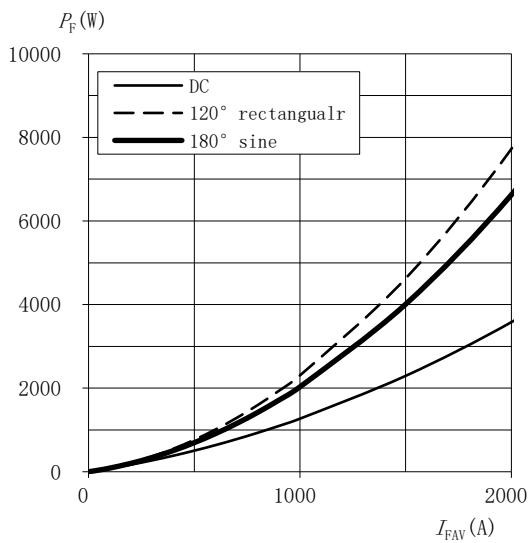

Fig. 3 : On-state power loss (P_F) vs. average on-state Current (I_{FAV})

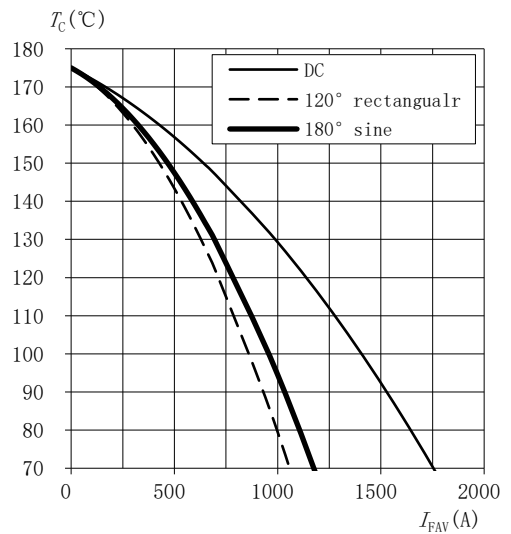

Fig.4 : Max. permissible case temperature(T_c) vs. average on-state current(I_{FAV})

Prepared by : ABA	Date of Publication : 31.08.2018
Approved by :	Revision : 0

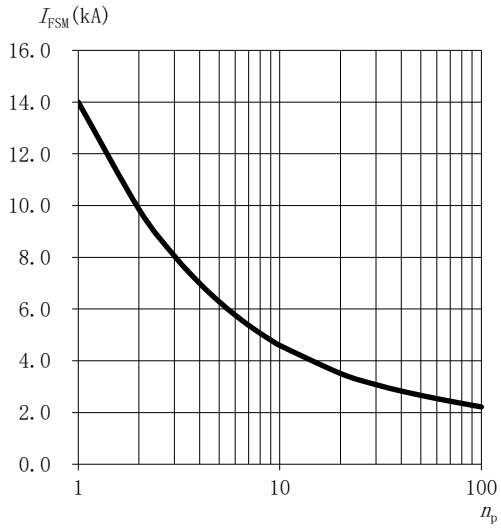

Fig.5: Surge on-state current (I_{FSM}) vs. number of pulses (n_p)

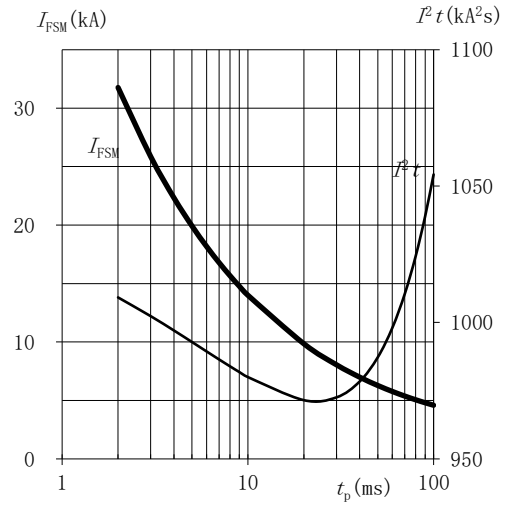
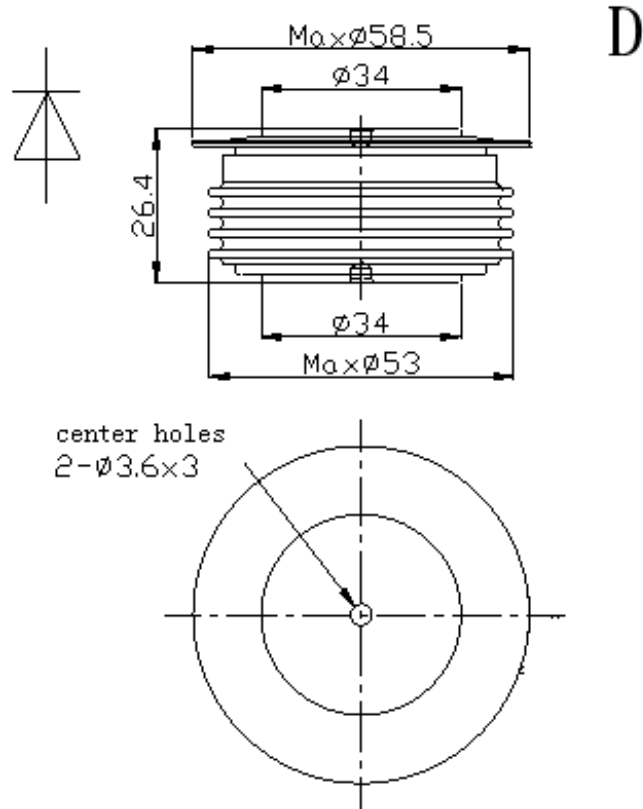

Fig.6: Surge on-state current (I_{FSM}) and surge current Integral (I^2t) vs. pulse length (t_p)

Outline :



MS Power GmbH

Mergenthalerallee 79-81
 65760 Eschborn, Germany
 Web: www.mspowergroup.com
 Mail: info@mspowergroup.de

Sales & Enquiry:

sales@mspowergroup.de

Technical Support:

solution@mspowergroup.de

After sales Service:

service@mspowergroup.de

Phone: +49 (0) 6196/7768 666

Fax: +49 (0) 6196/7757 888



Prepared by : ABA	Date of Publication : 31.08.2018
Approved by :	Revision : 0