



Key Parameters

V_{DRM} / V_{RRM}	= 1800V
$I_{T(AV)}$	= 600A
I_{TSM}	= 17000A
$V_{T(TO)}$	= 0.80V
r_T	= 0.23mΩ

Features

- Full blocking capability over wide temperature range
- Heat transfer through aluminium oxide ceramic isolated metal baseplate
- Pressure contacts technology for high reliability
- UL Recognized, file no. E505556

Applications

- Power Supplies
- DC motor control
- Controlled Rectifiers
- AC switch

Ordering Information

MS	TT	600	K	18
Fixed code	TT- Thyristor- Thyristor Module	Current Code	Technology K = Pressure Contact Technology	Voltage Code Code X 100 = V_{DRM}/V_{RRM}
Order Code MS TT600K18 : 1800V V_{DRM}, V_{RRM} , Thyristor-Thyristor Module				

Prepared by : ABA	Date of Publication : 25.03.2015
Approved by : RBS	Revision : 1

Symbol	Characteristic	Conditions	T _j [°C]	Value	Unit
BLOCKING					
V _{RRM}	Repetitive peak reverse voltage		125	200 - 1800	V
V _{RSM}	Non-repetitive peak reverse voltage		125	300 - 1900	V
V _{DRM}	Repetitive peak off-state voltage		125	200 - 1800	V
I _{RRM}	Repetitive peak reverse current	V = V _{RRM}	125	200	mA
I _{DRM}	Repetitive peak off-state current	V = V _{DRM}	125	200	mA
CONDUCTING					
I _{T(AV)}	Mean on state current	180° sin ,50 Hz, T _c =85°C		600	A
I _{RMS}	RMS on-state current			942	A
I _{TSM}	Surge on-state current	Sine wave, 10 ms Without reverse voltage	25	17000	A
			125	14000	A
I ² t	I ² t	Sine wave, 10 ms Without reverse voltage	25	1445 x 10 ³	A ² s
			125	980 x 10 ³	A ² s
V _T	On-state voltage	On-state current = 1500A	125	1.35	V
V _{T(TO)}	Threshold voltage		125	0.80	V
r _T	On-state slope resistance		125	0.23	mΩ
SWITCHING					
di/dt	Critical rate of rise of on-state current		125	200	A/μs
dv/dt	Critical rate of rise of off-state voltage	V _{DR} = 67%V _{DRM}	125	1000	V/μs
GATE					
I _{gt}	Gate trigger current	V _D =6V	25	200	mA
V _{gt}	Gate trigger voltage	V _D =6V	25	3.0	V
I _H	Holding current	V _D =6V, gate open circuit	25	300	mA
I _L	Latching current	V _D =6V	25	1500	mA
MOUNTING					
R _{th(j-c)}	Thermal impedance, sin 180°	Junction to case, per arm per module		0.058 0.029	°C/W
R _{th(j-c)}	Thermal impedance, rec120°	Junction to case, per arm per module		0.067 0.034	°C/W
R _{th(c-h)}	Thermal impedance	Case to heatsink, per arm per module		0.02 0.01	°C/W
T _j	Max. junction temperature			125	°C
T _{stg}	Storage temperature			-40 ... 150	°C
V _{ISOL}	Insulation test voltage,RMS	F=50Hz, 1min		3.0	KV
M1	Mounting torque			6 ± 15%	Nm
M2	Terminal connection torque			12 ± 15%	Nm
W	Weight (Approx.)			1450	gm
	File No.			E505556	
			Prepared by : ABA	Date of Publication : 25.03.2015	
			Approved by : RBS	Revision : 1	

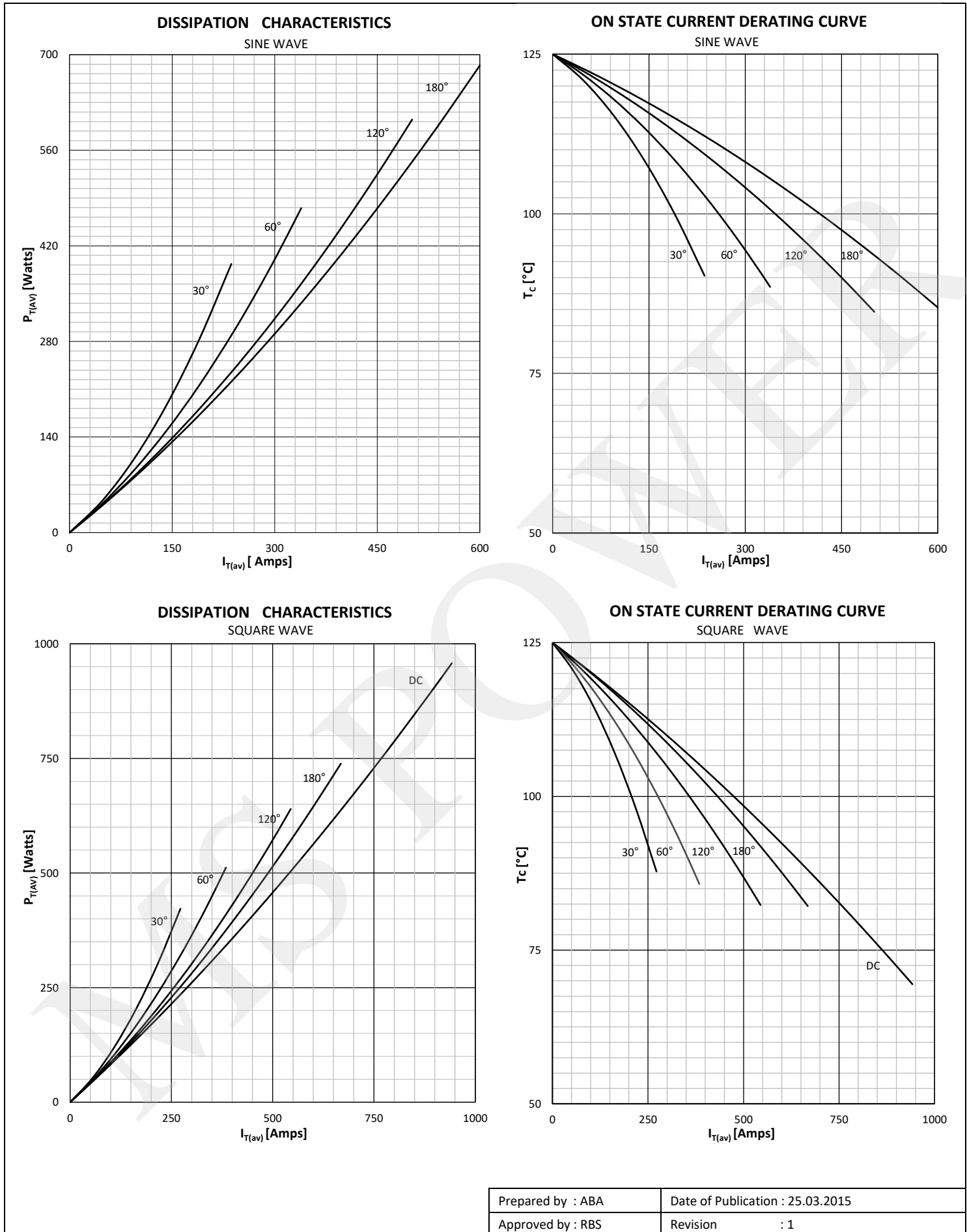

ON -STATE CHARACTERISTIC

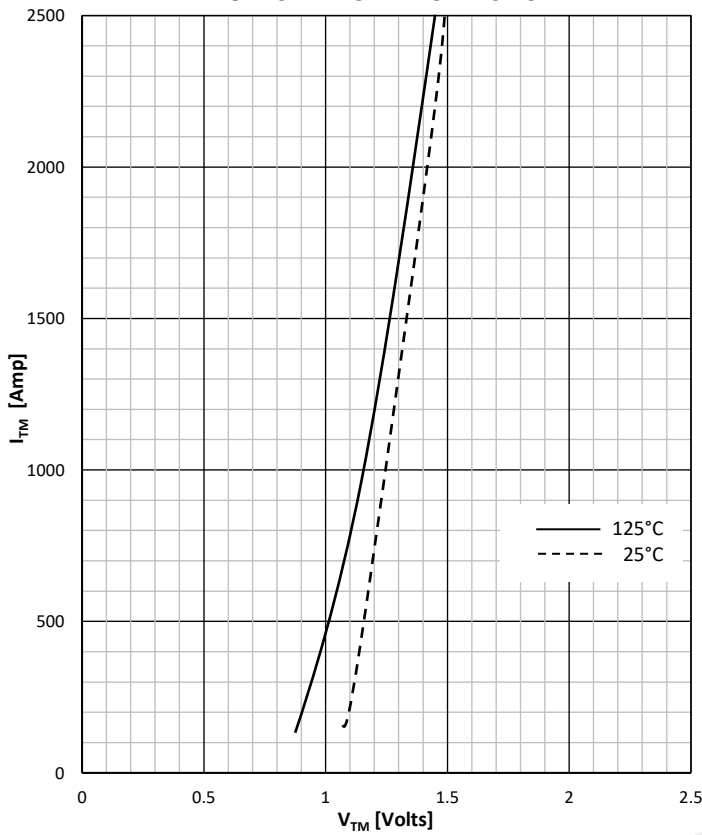

SURGE CHARACTERISTICS

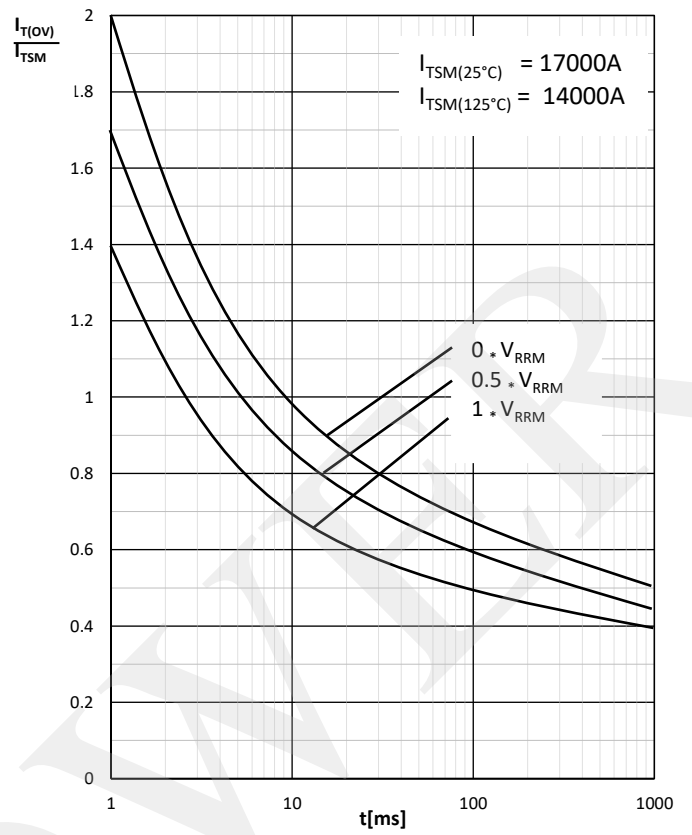

TRANSIENT THERMAL IMPEDANCE, PER ARM

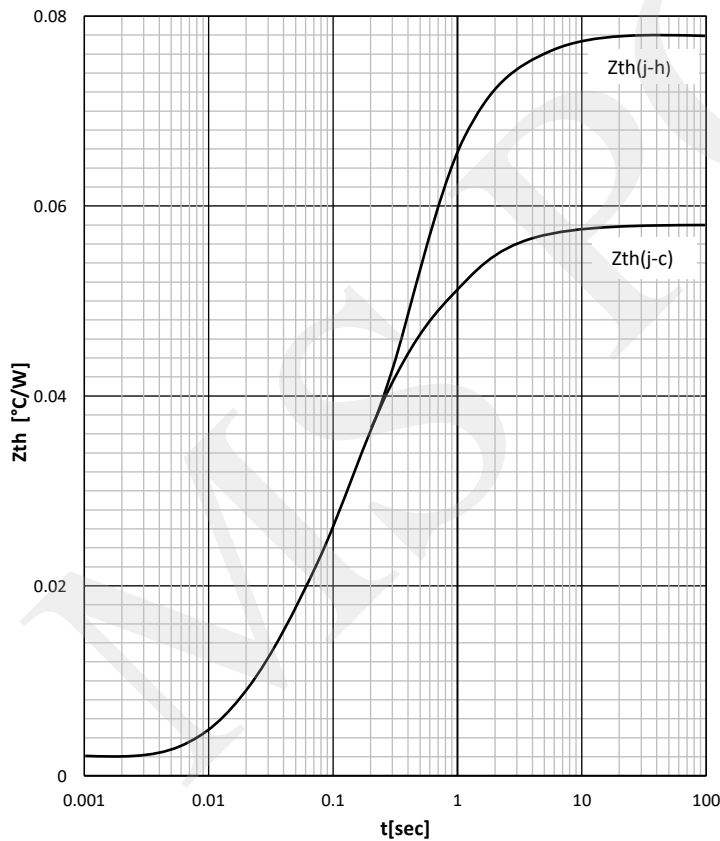

GATE TRIGGER CHARACTERISTICS

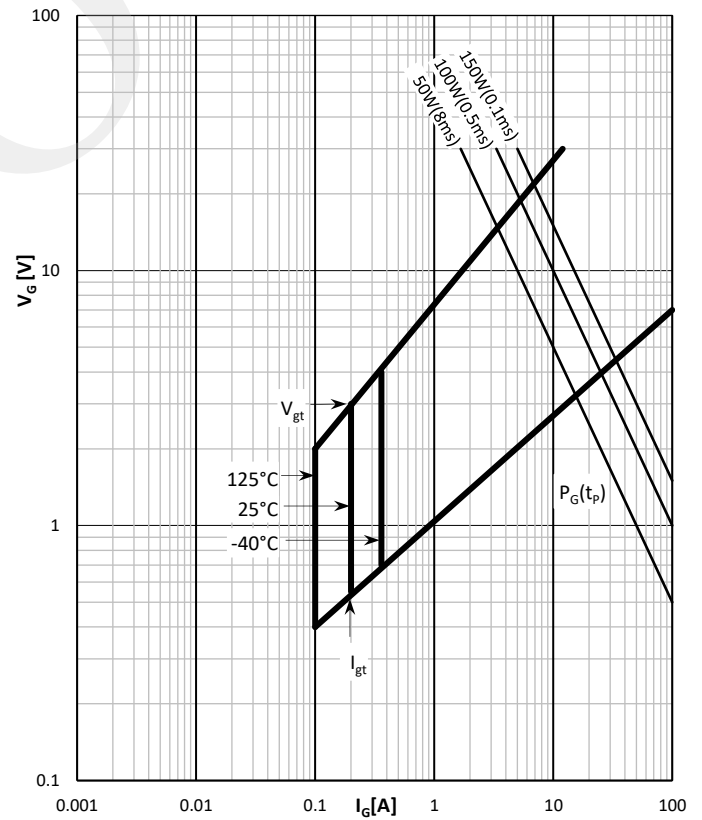

Prepared by : ABA

Date of Publication : 25.03.2015

Approved by : RBS

Revision : 1

Outline

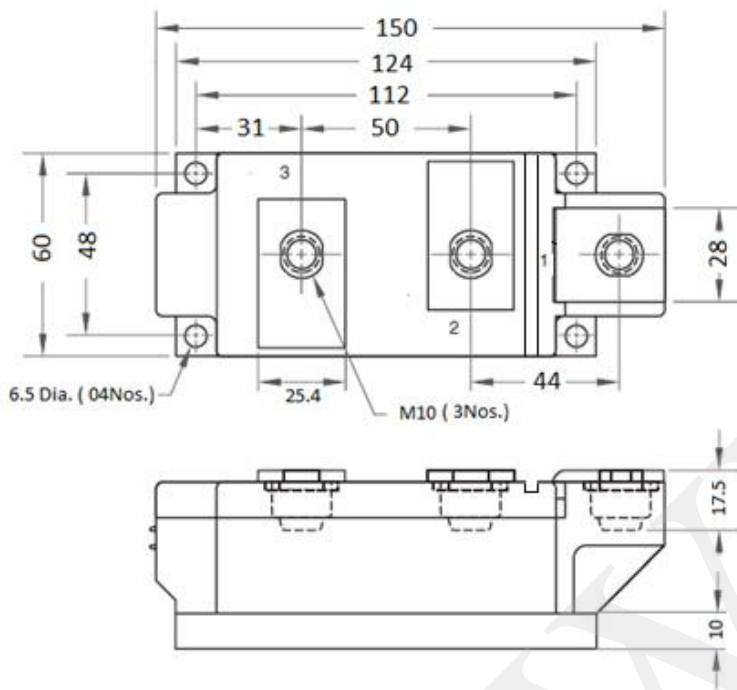

Note : All dimensions are in mm.
Tolerance : $\pm 0.5\text{mm}$

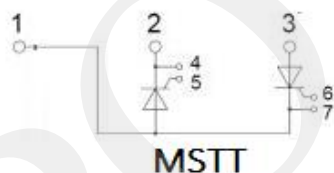

MS Power GmbH

Mergenthalerallee 79-81
65760 Eschborn, Germany
Web: www.mspowergroup.com
Mail: info@mspowergroup.de

Sales & Enquiry:

sales@mspowergroup.de

Technical Support:

solution@mspowergroup.de

After sales Service:

service@mspowergroup.de

Phone: +49 (0) 6196/7768 666

Fax: +49 (0) 6196/7757 888



Prepared by : ABA

Date of Publication : 25.03.2015

Approved by : RBS

Revision : 1

Terms & Conditions of usage :

The data contained in this product datasheet is exclusively Intended for technically trained staff. You and your technical departments will have to evaluate the suitability of the product for the intended application and the completeness of the product data with respect to such application. This product datasheet is describing the characteristics of this product for which a warranty is granted. Any such warranty is granted exclusively pursuant the terms and conditions of the supply agreement. There will be no guarantee of any kind for the product and its characteristics. The information in the valid application-and assembly notes of the device must be considered.

Should you require product information in excess of the data given in this product datasheet or which concerns the specific application of our product, please contact the sales office, which is responsible for you (see www.mspowergroup.com). For those that are specifically interested we may provide application notes.

Due to technical requirements our product may contain dangerous substances. For information on the types in question please contact the sales office, which is responsible for you.

Should you intend to use the Product in aviation applications, in health or live endangering or life support applications, please notify. Please note, that for any such applications we urgently recommend

- to perform joint Risk and Quality Assessments;
- the conclusion of Quality Agreements;
- to establish joint measures of an ongoing product survey, and that we may make delivery depended on the realization of any such measures.

If and to the extent necessary, please forward equivalent notices to your customers.

Changes of this product datasheet are reserved.

Prepared by : ABA	Date of Publication : 25.03.2015
Approved by : RBS	Revision : 1